

90° Short Radius Elbow

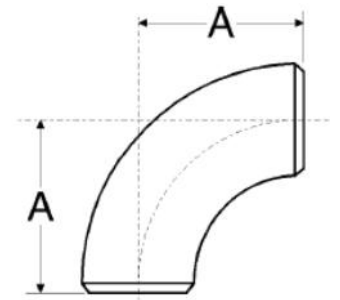

ASTM A403 / ANSI B16.9 / ANSI B16.28

Part Number	Nominal Pipe Size	Schedule	Dimensions (mm)			Weight Kg/Pce
			O.D	Wall Thickness	A	
025BWESRS804	1"	80s	33.4	4.55	25.4	0.16
032BWESRS804	1¼"	80s	42.2	4.85	31.8	0.26
040BWESRS804	1½"	80s	48.3	5.08	38.1	0.32
050BWESRS804	2"	80s	60.3	5.54	50.8	0.60
065BWESRS804	2½"	80s	73.0	7.01	63.5	1.16
080BWESRS804	3"	80s	88.9	7.62	76.2	1.70
100BWESRS804	4"	80s	114.3	8.56	101.6	3.64
125BWESRS804	5"	80s	141.3	9.52	127.0	6.80
150BWESRS804	6"	80s	168.3	10.97	152.4	12.70
200BWESRS804	8"	80s	219.1	12.70	203.2	25.10
250BWESRS804	10"	80s	273.1	12.70	254.0	38.80
300BWESRS804	12"	80s	323.9	12.70	304.8	60.00

*Grade 304/L

*Schedule 80s Wall Thickness

*Seamless Construction

*Dimensions are for guidance only – Please call to confirm if critical!